



Schweizerische Eidgenossenschaft
Confédération suisse
Confederazione Svizzera
Confederaziun svizra

Swiss Confederation

Innosuisse – Swiss Innovation Agency

leanPredict: Datenerfassung, Auswertung und Prognosealgorithmen

24. Januar 2019, Prof. Dr. Christian Bermes

christian.bermes@hsr.ch

Umfeld und Projektziel



- > Paketsortierzentrum mit Kippschalensortierbändern
- > Vorhersage des Ausfalls der einzelnen Sortierwagen durch **nachrüstbares System**
 - » Reduzierung ungeplanter Ausfälle
 - » Erhöhung der Anlagenverfügbarkeit

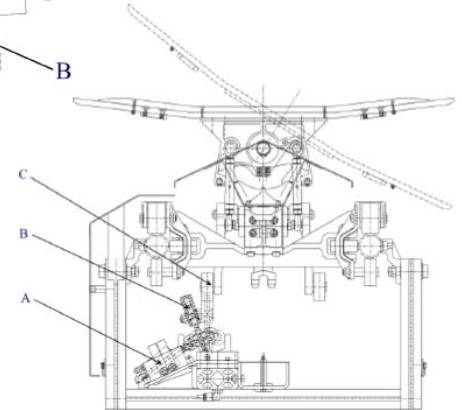
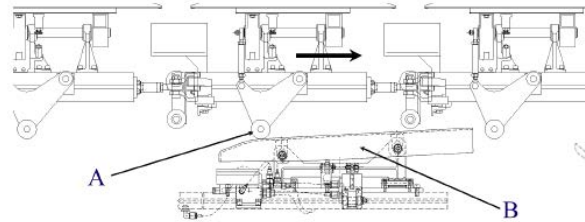

Datenerfassung: Ziel

Folgende Zustände sollen detektiert werden:

- a) Beschädigte Raste
(Horizontal Verriegelung)
 - b) Verkrümmung Rückstellung
 - c) Verkrümmung des Fahrwerks
 - d) Abnutzung der Rollen/Lager
 - e) Abnutzung der Gelenk
Wagenverbindung
- Farbkennung: Prio1 Prio2 Prio3

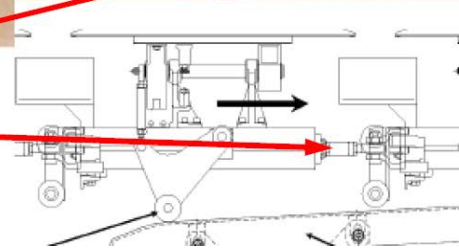
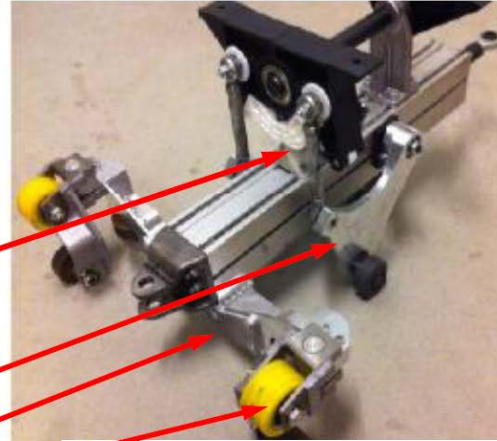

Datenerfassung: optisches Messsystem

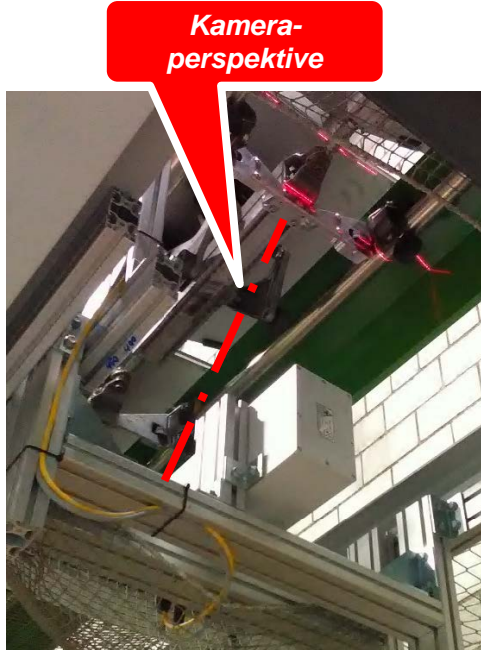
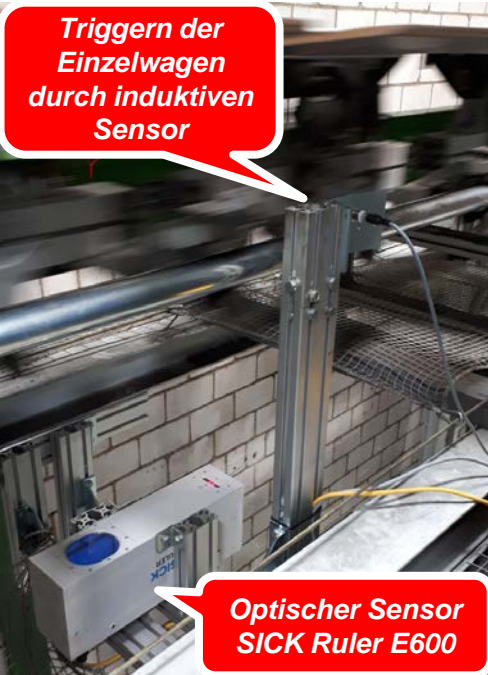

Datenerfassung: Höhenprofile und Flächen



3D-Bild im EasyRanger: Profillinie

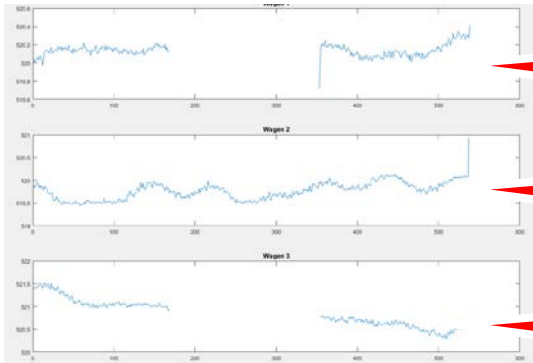

«Normale»
Profillinie

«Schwingende»
Profillinie

«Tendenz unten»
Profillinie



**3D-Bild im EasyRanger mit Feature
'Flächen'**

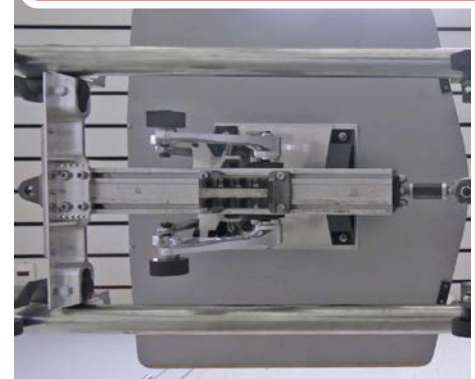

Datenauswertung: Extraktion relevanter Features

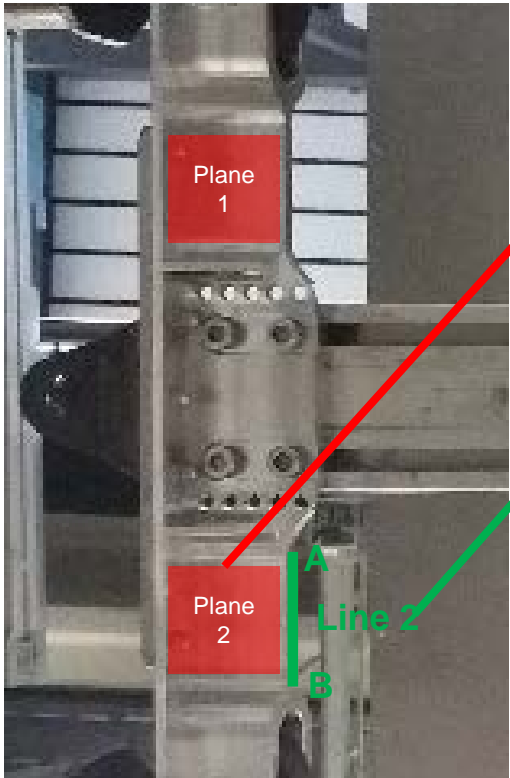

Feature group	Feature explanation	Feature ID
Plane 2, center of gravity	x	04
	y	05
	z	06
...
Line 2	x(A)	12
	y(A)	13
	x(B)	14
	y(B)	15

Prognosealgorithmen: leanBI und Dr. Marc Tesch (Pause und Apèro)

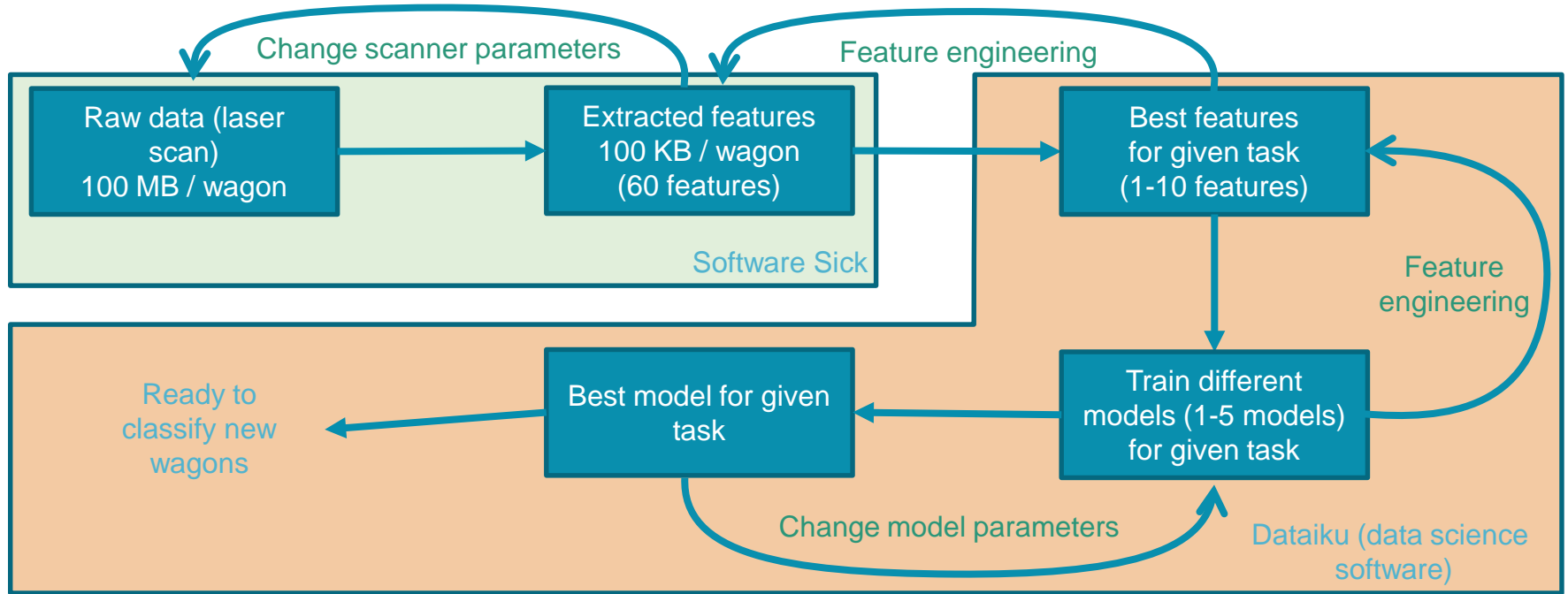

Wirkungsfelder der Partner

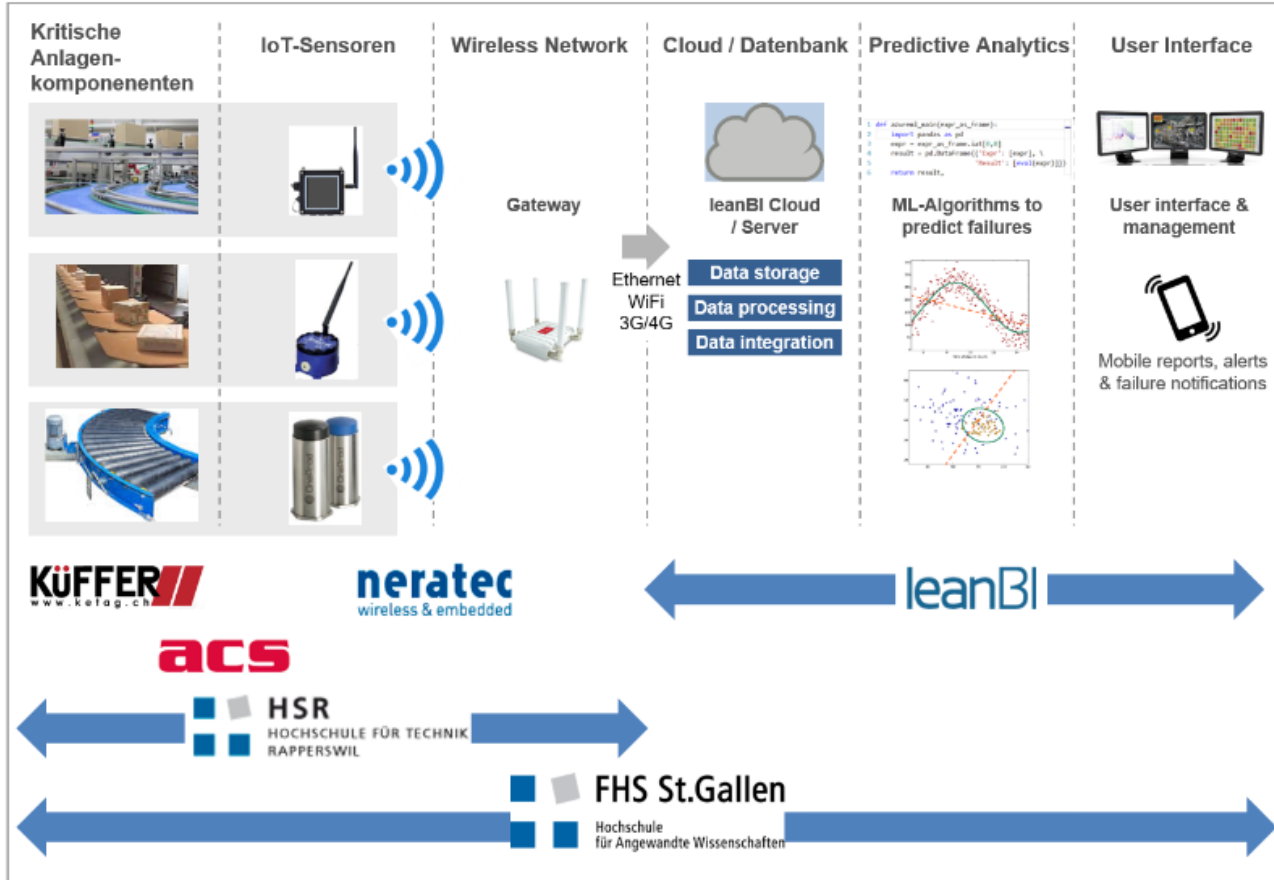

PHYSISCH

CYBER

DANKE!



Dr. Christian
Heumann
Projektleiter



Prof. Dr. Franziska
Weis
Projektmitarbeiterin



Prof. Dr. Christian
Bermes
Teilprojektleiter



Benjamin
Eggimann
Projektmitarbeiter



Dr. Marc Tesch
CEO, Stellv.
Projektleiter



Thomas Nufer
Fachverantwortlicher
Anlagetechnik



Michael Kummer
Geschäftsführer



Hans Kaufmann
Geschäftsführer



Roland Bieri
Geschäftsführer



DigitalLab@HSR

Thomas Friedli

+41 71 224 72 61
Thmas.friedli@unisg.com

Simon Erdmann

+41 79 397 66 31
simon.erdmann@cognizant.com

Felix Nyffenegger

+41 76 431 00 88
felix.nyffenegger@hsr.ch

CHRISTIAN BERMES

+41 78 641 13 85
christian.bermes@hsr.ch

Roman Hänggi

+41 55 222 46 03
roman.haenggi@hsr.ch

Henrik Nordborg

+41 55 222 43 70
henrik.nordborg@hsr.ch

